

GREEN POWER VOLVO DIESEL ENGINE

1500 RPM	Type GP410VO
-----------------	---------------------

The Engine with integrated water cooling

Engine: TAD1344GE

Technical description

- Cast iron cylinder block with optimum distribution of forces without the block being unnecessarily heavy
- Piston cooling for low piston temperature and reduced ring temperature
- Tapered connecting rods for increased piston lifetime
- Crankshaft induction hardened bearing surfaces and fillets with seven bearings for moderate load on main and big end bearings
- Replaceable valve guides and valve seats
- Keystone top compression rings for long service life
- Viscous type crankshaft vibration dampers to withstand single bearing alternator torsional vibrations
- Over head camshaft and four valves per cylinder
- Case hardened and Nitrocarburized transmission gears for heavy duty operation
- Wet and replaceable cylinder liners

Benefits

- Low noise emission, cost savings as no noise attenuation measures are required
- Long service intervals: 1000 hour oil change intervals and low fuel consumption bring savings in Operating costs
- Low installation costs
- Excellent load takeover characteristics ensure prompt power supply
- Combined oil cooling and lubrication prevents corrosion and cavitation
- High reliability and durability together with reduced maintenance requirement and wear parts

Model Designation

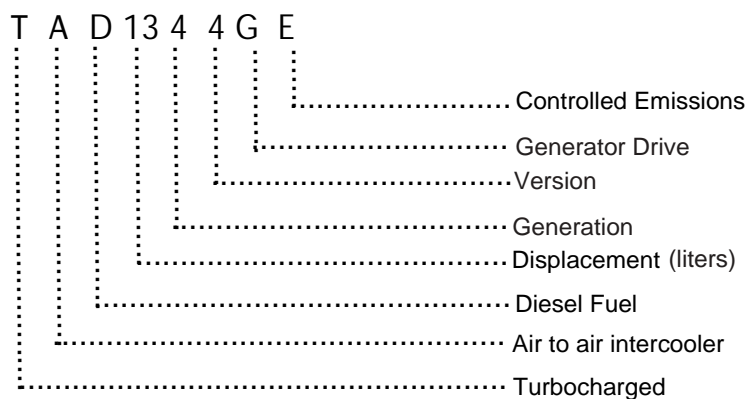

Control Panel

Manual or Automatic start control panel

- Manual or automatic remote boot controller, selector switch for Off, Man and Auto with the key.
- Complete motor protection functions with alarms visualized via LEDs in the front.
- The control unit 6 is set via DIP switches in the rear part of the case.
- Standard circuit breaker and differential relay.

Rating Table : The Genset TAD1344GE Engine

Engine type	TAD1344GE		
Speed	min ⁻¹ rpm	1500	
Frequency	Hz	50	
Engine Power			
Prime power (PRP)	kVA kW	410	328
Limited time running power (LTP)	kVA kW	452	362
Spec. fuel consumption PRP (LTP)			
100 % load	g/KWh lb/hph	194	0.314
75 % load	g/KWh lb/hph	197	0.319
50% load	g/KWh lb/hph	200	0.324
25 % load	g/KWh lb/hph	219	0.355

PRP* kVA/KW :

Available electrical power (at variable load) in a medium of 80% of the indicated maximum power.
A 10% overload capacity is available.

LTP** kVA/KW :

Available electrical power load (at variable load) for a maximum of 500 hours per year.
No overload capability available

Scope of supply :

The engine and alternator are mounted together forming a rigid monoblock, the shoulders are connected by inflexible disc connection. The mono-block is mounted on a steel base frame through silent blocks. The base frame is including a fuel tank. Starting is electric and it contains a battery. The generator monitoring system consists of a control module.

Technical Data

Engine type	TAD1344GE	
Numer of cylinder	6	
Bore x Stroke	mm	131 x 158
Displacement	l	12.78
Compression ratio	18.1:1	
Engine Power PRP	KW	328
Engine Power LTP	KW	362
Cooling Type	water	
Injection Type	Electronic unit	
Max allowable Back pressure	Kpa	10
Max Permitted air Intake restriction	Kpa	5
Standard Governor	Electronic	
Oil system capacity	Litres	36
Battery	Ah	80
Starting engine	KW	5.0
Exhaust gas flow	m ³ /min	67.5
Exhaust gas Temperature	°C	465

Dimensions

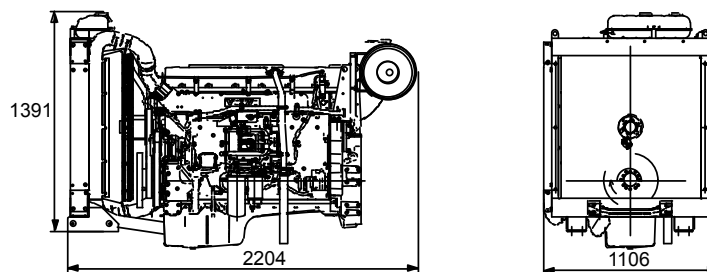

Engine type	Length	Width	Height
TAD1344GE mm	2204	1106	1391

Engine Illustration

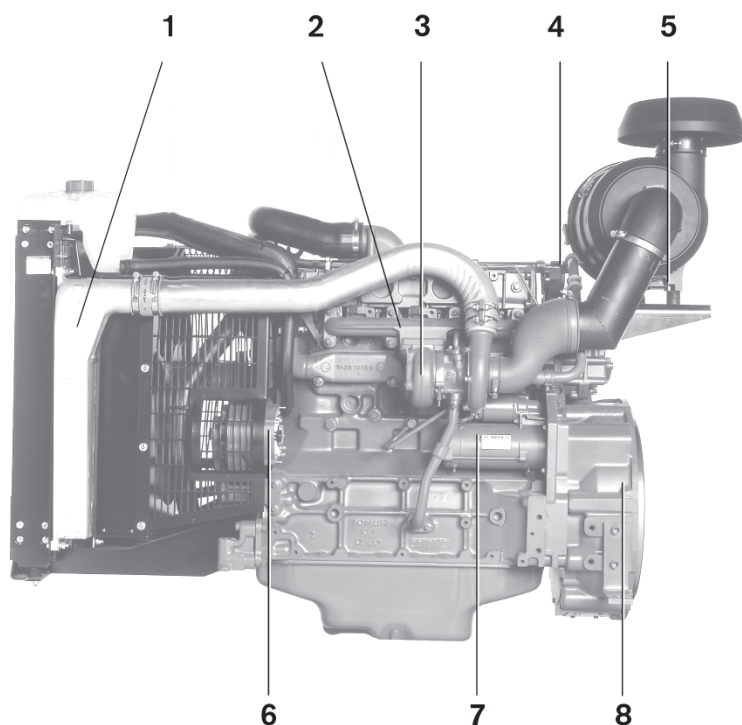

Engine Description

TAD1344GE

- 1 Charged air cooler
- 2 Exhaust manifolds
- 3 Turbochargers
- 4 Closed crankcase system
- 5 Air restriction indicator
- 6 Alternator
- 7 Starter
- 8 Flywheel housing
- 9 Air filters
- 10 Fuel governor
- 11 Stop solenoid
- 12 Coolant heater
- 13 Oil filling
- 14 Oil cooler
- 15 Tank filler cap
- 16 Engine transmission with PTO
- 17 Oil filter
- 18 Fuel filter
- 20 Radiator

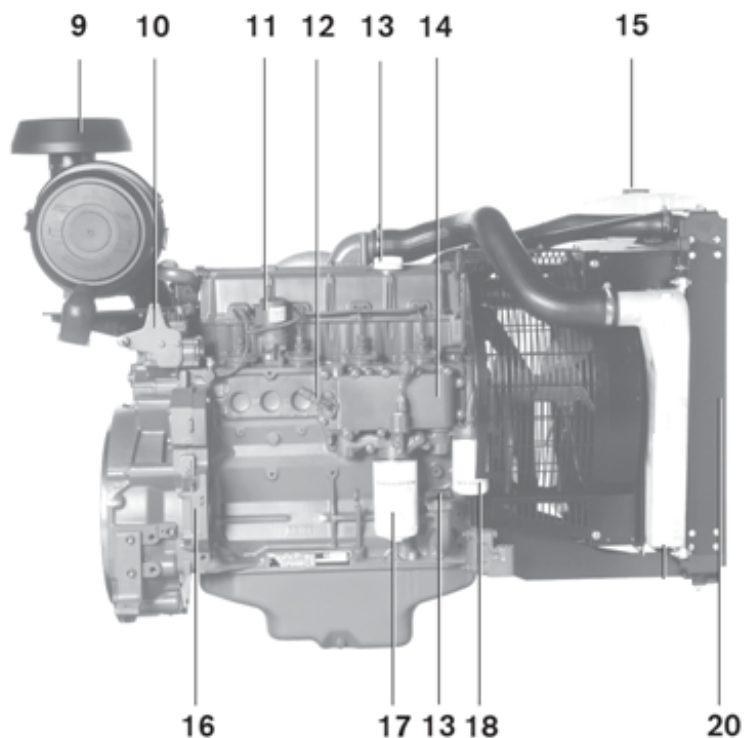

Greenpower AB

Helsingborgsvägen Varalöv
 262 96 Ängelholm, Sweden
 Tel: +46 431-222 40
 E-mail: info@greenpower.se
 web:www.greenpower.se